

Tregaskiss Style MIG Welding Torch Parts

Designed in Europe and manufactured in accordance with ISO 9001 and comply with EN60974-7.

All welding torch parts are manufactured to the same specs as the OEM, however Euromarc parts are made with a harder and higher conductivity copper alloy than the original equipment specs to give you a more reliable longer lasting MIG gun that performs the way it should.

Tregaskiss Style 300-400

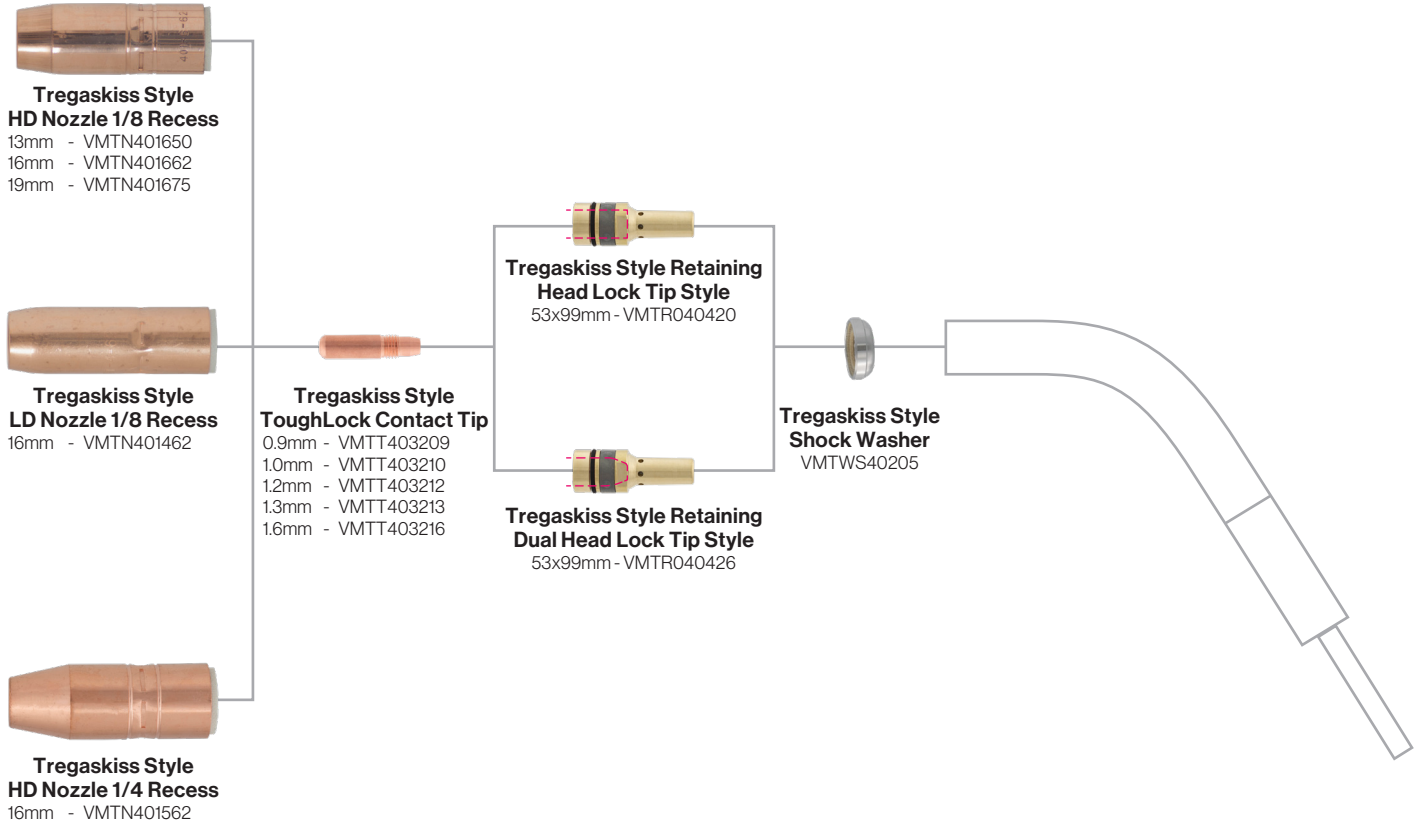

Tregaskiss Style Contact Tips

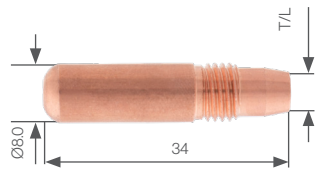

Tregaskiss Style ToughLock Contact Tip

Wire	Size	Ref	Code
0.9mm	8x34mm	403-20-35	VMTT403209
1.0mm	8x34mm	403-20-10	VMTT403210
1.2mm	8x34mm	403-20-45	VMTT403212
1.3mm	8x34mm	403-20-52	VMTT403213
1.6mm	8x34mm	403-20-116	VMTT403216

Other

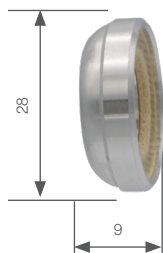

Tregaskiss Style Shock Washer

Size	Ref	Code
28x9mm	402-5	VMTWS40205

Tregaskiss Style Diffusers

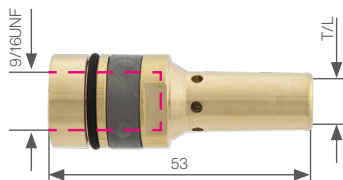

Tregaskiss Retaining Head Lock Tip Style

Size	Ref	Code
53x19mm	404-20	VMTR040420

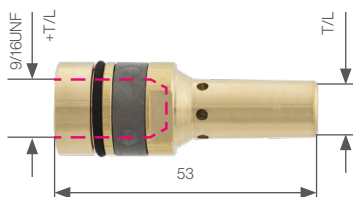

Tregaskiss Retaining Dual Head Lock Tip Style

Size	Ref	Code
53x19mm	404-26	VMTR040426

Tregaskiss Style Nozzels

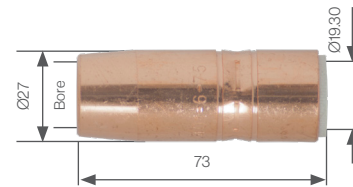

Tregaskiss Style HD Nozzels 1/8 recess

Bore Ø	Size	Shape	Ref	Code
13mm	27x73mm	Tapered	401-6-50	VMTN401650
16mm	27x73mm	Conical	401-6-62	VMTN401662
19mm	27x73mm	Cylindrical	401-6-75	VMTN401675

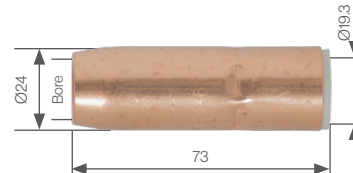

Tregaskiss Style LD Nozzle 1/8 recess

Bore Ø	Size	Shape	Ref	Code
16mm	24x73mm	Conical	401-4-62	VMTN401462

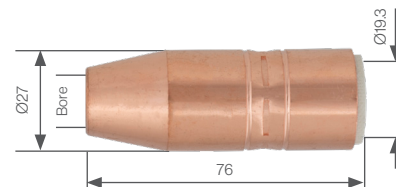

Tregaskiss Style HD Nozzle 1/4 recess

Bore Ø	Size	Shape	Ref	Code
16mm	27x76mm	Conical	401-5-62	VMTN401562

Tregaskiss Style Liners



Tregaskiss Style Steel Liner 4.5

Wire	Length	Ref	Code
0.9-1.2mm	4.5m	415-35-15	VMTL415124



Tregaskiss Style Steel Liner 4.5

Wire	Length	Ref	Code
1.2-1.6mm	4.5m	415-116-15	VMTL415164